



Give life to your project

C150, C200, C300 Plank



C150, C200, C300 Plank

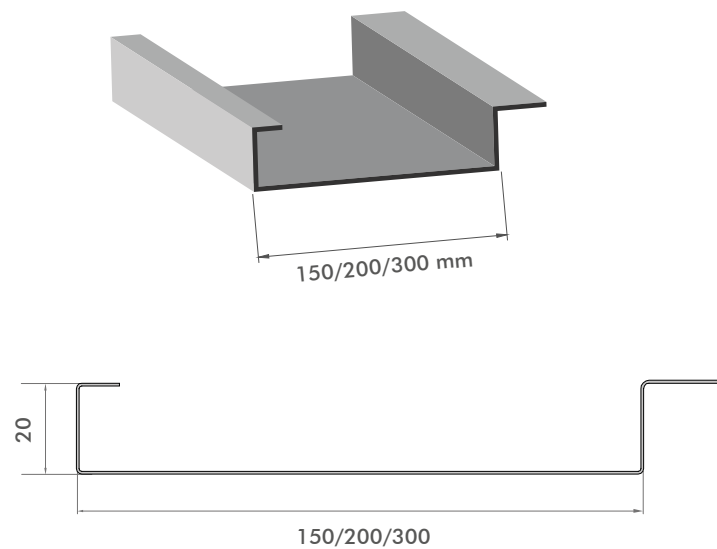

Description

The plank C150/C200/C300 is a simple and quick system to be installed and during the inspection.

The plank C150/C200/C300 is a model that combines flexibility, functionality and style, allowing you to choose the size that best meets technical and aesthetics project requirements.

This model is available both indoors and outdoors.

Main features

Dimensions	-C150, C200, C300 Plank: 150 mm; 200 mm; 300 mm
Height	20 mm
Gap	none
Material, Thickness and Colour	-Coil coated Steel: 0,5 mm; 0,6 mm; 0,8 mm RAL 9003, 9006 -Coil coated Aluminum: 0,5 mm; 0,6 mm; 0,8 mm RAL 9003, 9006 (custom RAL on request)

C150, C200, C300 Plank _{mounted in support}

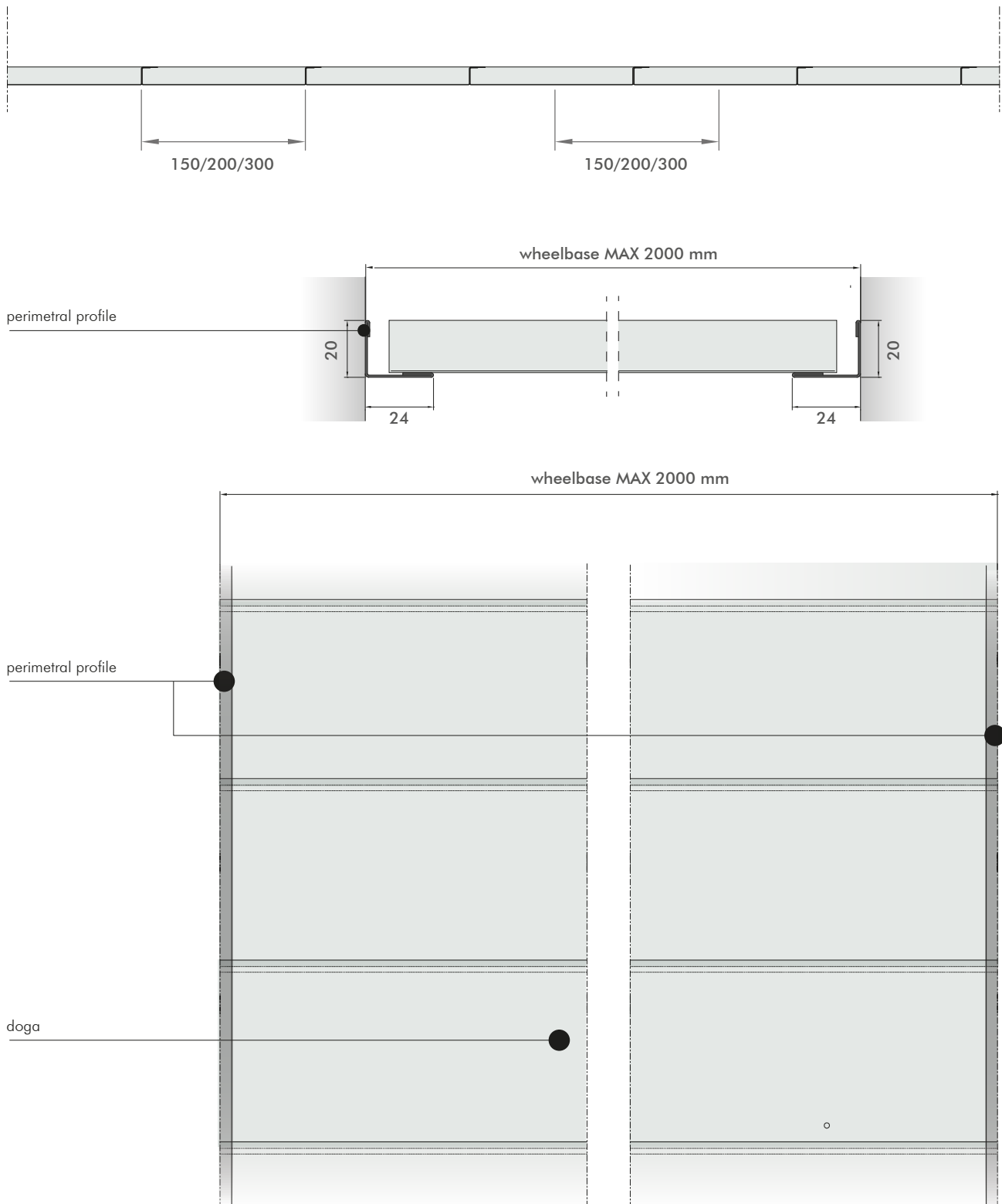

NOTE : wheelbase indicated refer to material mounted in interior spaces and completed by any "L" perimeter profile and are to be considered valid only in relation to the weight of the metal ceiling. These indications are generic and in any case remain to be verified for each individual order, in relation to the material identified for the crosspiece and plank, and relative thickness.

C150, C200, C300 Plank _{mounted with structure and without gap}

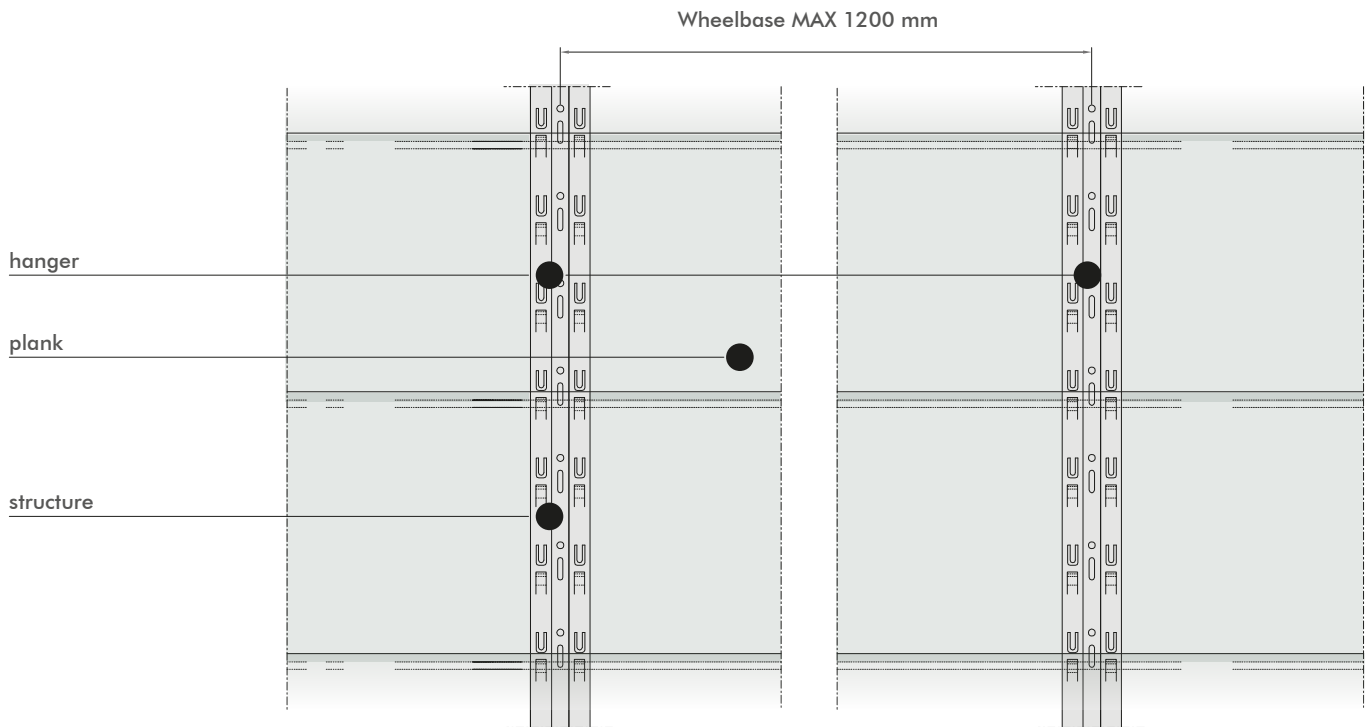
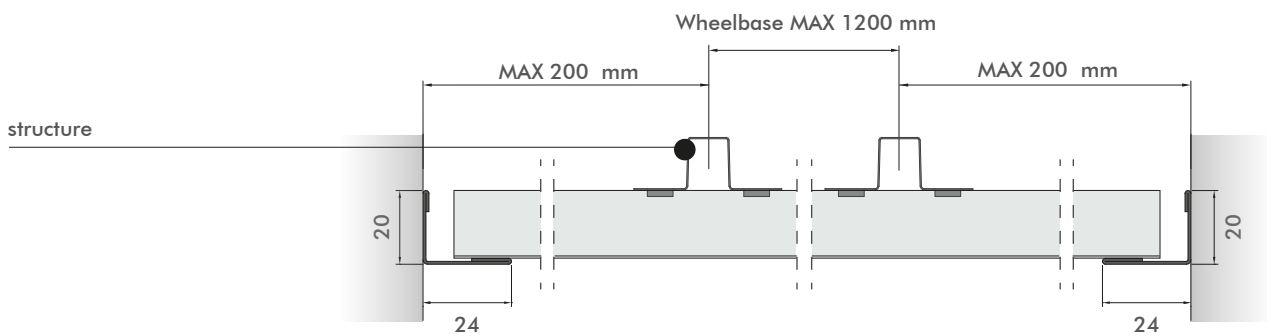
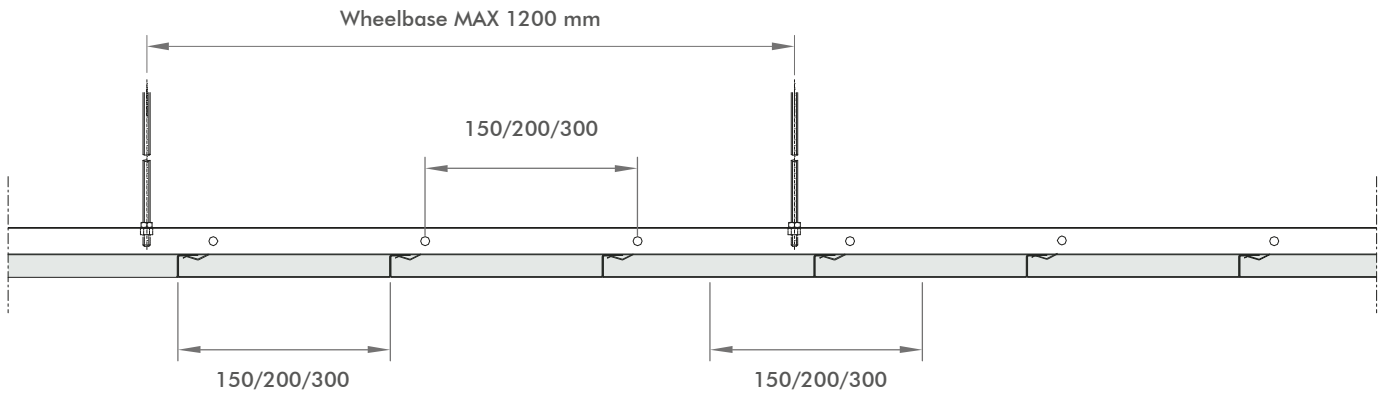

NOTE : wheelbase indicated refer to material mounted in interior spaces and completed by any "L" perimeter profile and are to be considered valid only in relation to the weight of the metal ceiling.
 These indications are generic and in any case remain to be verified for each individual order, in relation to the material identified for the crosspiece and plank, and relative thickness.

Mounting system

mounted in support

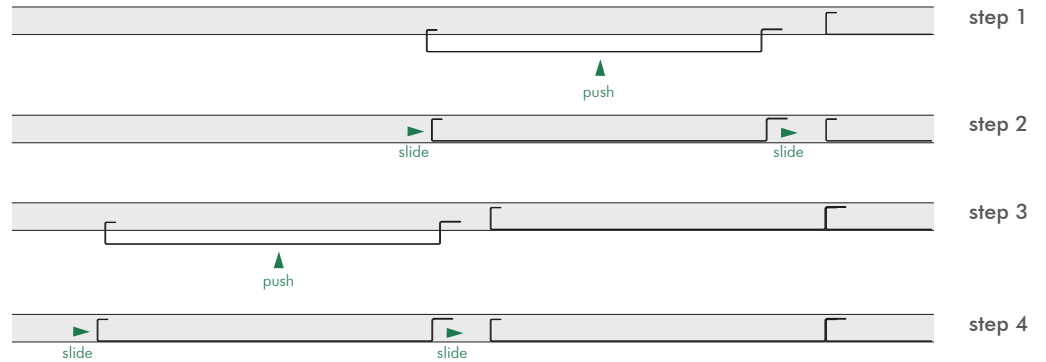

mounted with structure and without gap



Perimetral's details

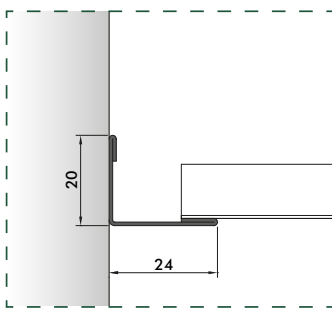

P2_L 3000 mm

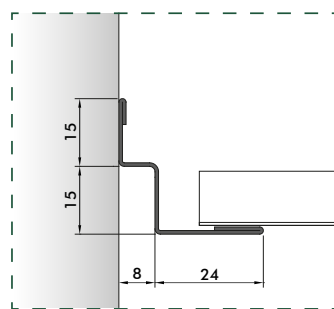

P11/A_L 3050 mm

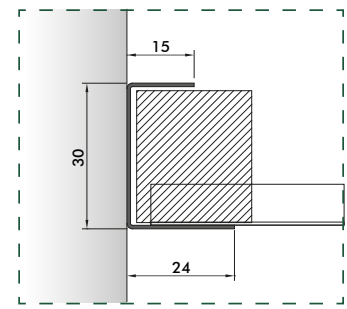







P10 *_L 3000 mm

Each profile can be achieved with customized section in according to customer's requests.

* Supplied on request with polystyrene to maintain in the form the cut panel (supplied not pre-assembled)

Performance and technical data

 Perforation type	 α_w *	 Classe**	 Recycled content (%)***	 Reaction to fire class****	 %RH
Plank not perforated	0,10	NC	<30	A1	95
R0701	0,55	D	<30	A1	95
R1511	0,70	C	<30	A1	95
R211	0,70	C	<30	A1	95
R2516	0,75	C	<30	A1	95
D1522	0,75	C	<30	A1	95
D222	0,70	C	<30	A1	95

* including non-woven fabric (black TNT) certified and hot applied.

** according to EN ISO 11654

*** please note that all aluminum and steel products are 100% recyclable.

**** Intended use of the product according to EN13964: 2014 / A1: 2006: Components of suspended ceiling membranes for internal use in buildings. System of assessment and verification of constancy of performance of the construction product: SYSTEM 3.

***** for any other technical information, please contact our sales or technical office.

Perforation Options

Diameter 2 mm

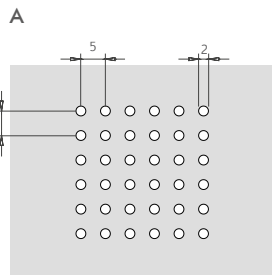

For width: 300
Perforation area: regular
Inter-axes: 5x5 mm
Perforation surface: 11% approx.

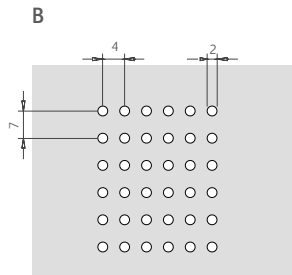

For width: 100 - 150 - 200
Perforation area: regular
Inter-axes: 4x7 mm
Perforation surface: 11% approx.

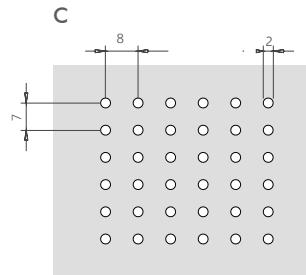

For width: 100 - 150 - 200
Perforation area: regular
Inter-axes: 8x7 mm
Perforation surface: 5% approx.

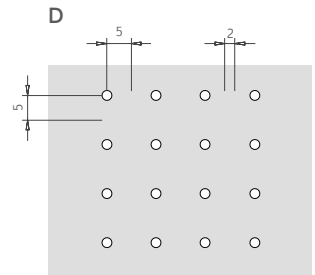

For width: 300
Perforation area: regular
Inter-axes: 10x10 mm
Perforation surface: 5,5% approx.

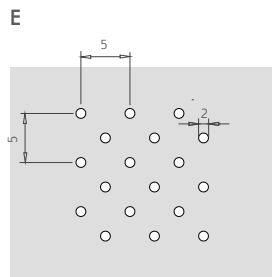

For width: 300
Perforation area: diagonal
Inter-axes: 5x5 mm
Perforation surface: 22% approx.

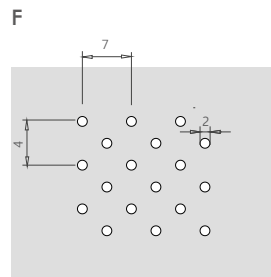

For width: 100 - 150 - 200
Perforation area: diagonal
Inter-axes: 4x7 mm
Perforation surface: 22% approx.

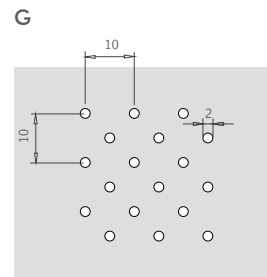

For width: 300
Perforation area: diagonal
Inter-axes: 10x10 mm
Perforation surface: 11% approx.

Diameter 3 mm

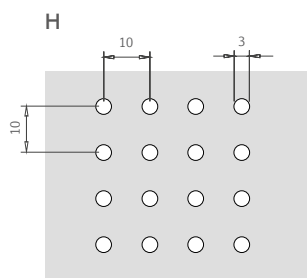

For width: 300
Perforation area: regular
Inter-axes: 10x10 mm
Perforation surface: 7% approx.

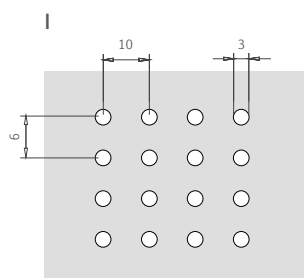

For width: 100 - 150 - 200
Perforation area: regular
Inter-axes: 10x6 mm
Perforation surface: 11% approx.

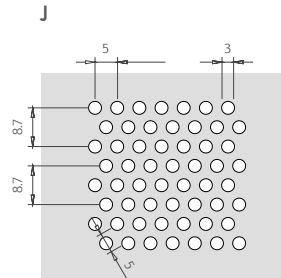

Diameter: 3 mm
Perforation area: diagonal
Inter-axes: 5x8.7 mm
Perforation surface: 32% approx.

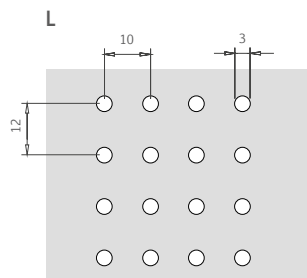

For width: 100 - 150 - 200
Perforation area: regular
Inter-axes: 10x12 mm
Perforation surface: 5% approx.

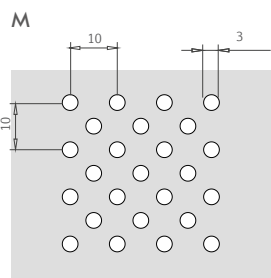

For width: 300
Perforation area: diagonal
Inter-axes: 10x10 mm
Perforation surface: 14% approx.

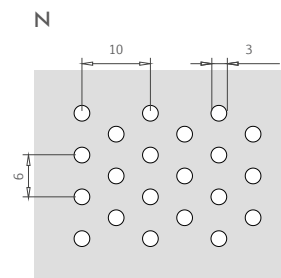

For width: 100 - 150 - 200
Perforation area: diagonal
Inter-axes: 10x6 mm
Perforation surface: 23% approx.

Perforation Options

Various

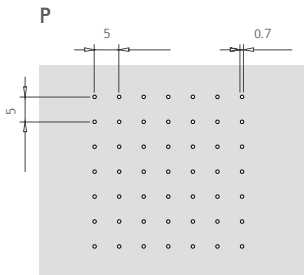

EXTRA MICRO PERFORATION
 Diameter: 0.7 mm
 Perforation area: regular
 Inter-axes: 5x5 mm
 For width: 100 - 150 - 200 - 300
 Perforation surface: 1% approx.

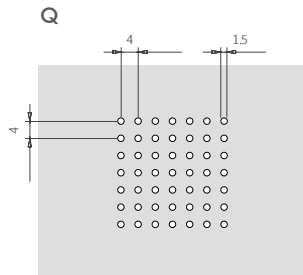

MICRO PERFORATION
 Diameter: 1.5 mm
 Perforation area: regular
 Inter-axes: 4x4 mm
 For width: 100 - 150 - 200 - 300
 Perforation surface: 11% approx.

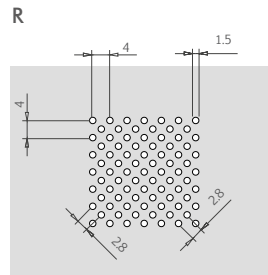

MICRO PERFORATION
 Diameter: 1.5 mm
 Perforation area: diagonal
 Inter-axes: 4x4 mm
 For width: 100 - 150 - 200 - 300
 Perforation surface: 22% approx.

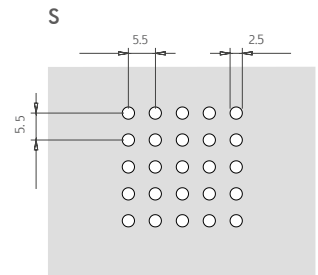

Diameter: 2.5 mm
 Perforation area: regular
 Inter-axes: 5.5x5.5 mm
 For width: 100 - 150 - 200 - 300
 Perforation surface: 16% approx.

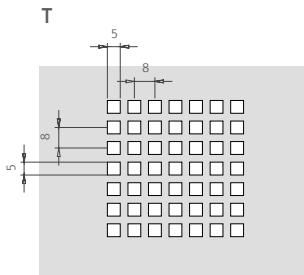

Hole: 5x5 mm
 Perforation area: square
 Inter-axes: 8x8 mm
 For width: 100 - 150 - 200 - 300
 Perforation surface: 40% approx.

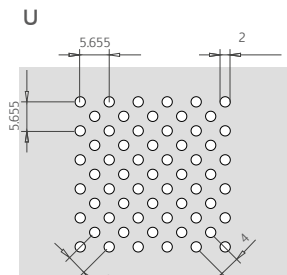

Diameter: 2 mm
 Perforation area: diagonal
 Inter-axes: 5.655x5.655 mm
 Perforation surface: 20% approx.

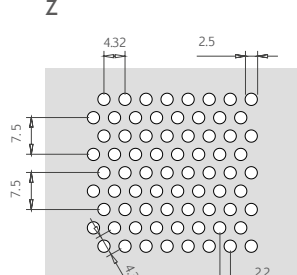

Diameter: 2.5 mm
 Perforation area: diagonal
 Inter-axes: 4.3x7.5 mm
 Perforation surface: 30% approx.

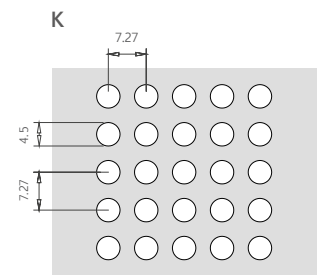

Diameter: 4.5mm
 Perforation area: regular
 Inter-axes: 7.27x7.27 mm
 Perforation surface: 30% approx.

General informations

Technical standards

All Profilsystem products are CE marked according to EN 13964. They are also accompanied by the Declaration of Performance (D.O.P.) as required by European regulation 305/11 concerning the placing of construction products on the market. For applications in particularly aggressive environments such as swimming pools, industrial installations with chemical and / or corrosive fumes, check the most suitable material and surface treatment with the technical or commercial office of Profilsystem.

Storage

All products are carefully packed and placed on special pallets and secured by strapping and film wrapping. On request we can provide the package complete of cardboard corners, bubble wrap and polystyrene to reduce the risks during transport.

It is always recommended to handle all packaging with the most care, avoiding shocks and practices that damage the contents. The packed material is stored in closed, clean and dry places until the time of pic-up.

Do not expose filmed products to heat sources and do not leave them under the sun.

Installation

The metal ceiling are installed manually by the installer depending on the type and model you choose.

The material should be stored in closed, clean and dry places until the time of installation.

Do not rest on the ground and not leave the products on site without the original package issued at the time of delivery.

Avoid the contact between material and water, solvents, degreasers and aggressive liquids.

Cleaning and Maintenance

Metal ceilings, thanks to the easy washing and cleaning are also a guarantee in terms of hygiene.

To remove dust, stains or smudges you can use carefully a clean, dry cloth or moistened with neutral detergent, or non-abrasive and non-aggressive disinfectants.



Give life to your project

ITALY

Head quarter & showroom

Via Don Luigi Sturzo,3 - 20822 Seveso (MB) Italy
tel: +39 0362 625652 - fax: +39 0362 306733
www.profilsystem.com

DUBAI

Sales offices & showroom

TOP 27 CONSULTING JLT
Office 3205 - JBC2
Cluster V - JLT
Dubai - United Arab Emirates
middleeast@profilsystem.com

CHILE

Sales offices & showroom

COMERCIAL E.V.A. Limitada
Avenida La Dehesa 1844
Oficio 714
Lo Barnechea, Santiago de Chile
tel: +59 9 51599037
info@nenzi.cl

SPAIN

Sales offices & showroom

PROFILSYSTEM EPC
Techos de Aluminio
C/ Lluís Companys, 52
08810 Sant Pere de Ribes, Barcelona
tel: +34 666 431 921
info@profilsystem.es

Our offices are at your disposal

SALES OFFICE ITALY:

Elis Zappino
elis@profilsystem.com
Skype ID [elis.zappino](#)

Dott. Riccardo Ghezzi
riccardo@profilsystem.com
Skype ID [ghezziriccardo](#)

EXPORT OFFICE:

Dott. Alexa Maj
export@profilsystem.com
Skype ID [Alexa Maj](#)

TECHNICAL OFFICE:

Arch. Manuela De Cristofaro
tecnico@profilsystem.com
Skype ID [Manuela De Cristofaro](#)

SHIPPING OFFICE:

Chiara Talon
chiara.talon@profilsystem.com
Skype ID [talon.chiara](#)