



PROFILSYSTEM[®]

Give life to your project

Panel H

Panel H

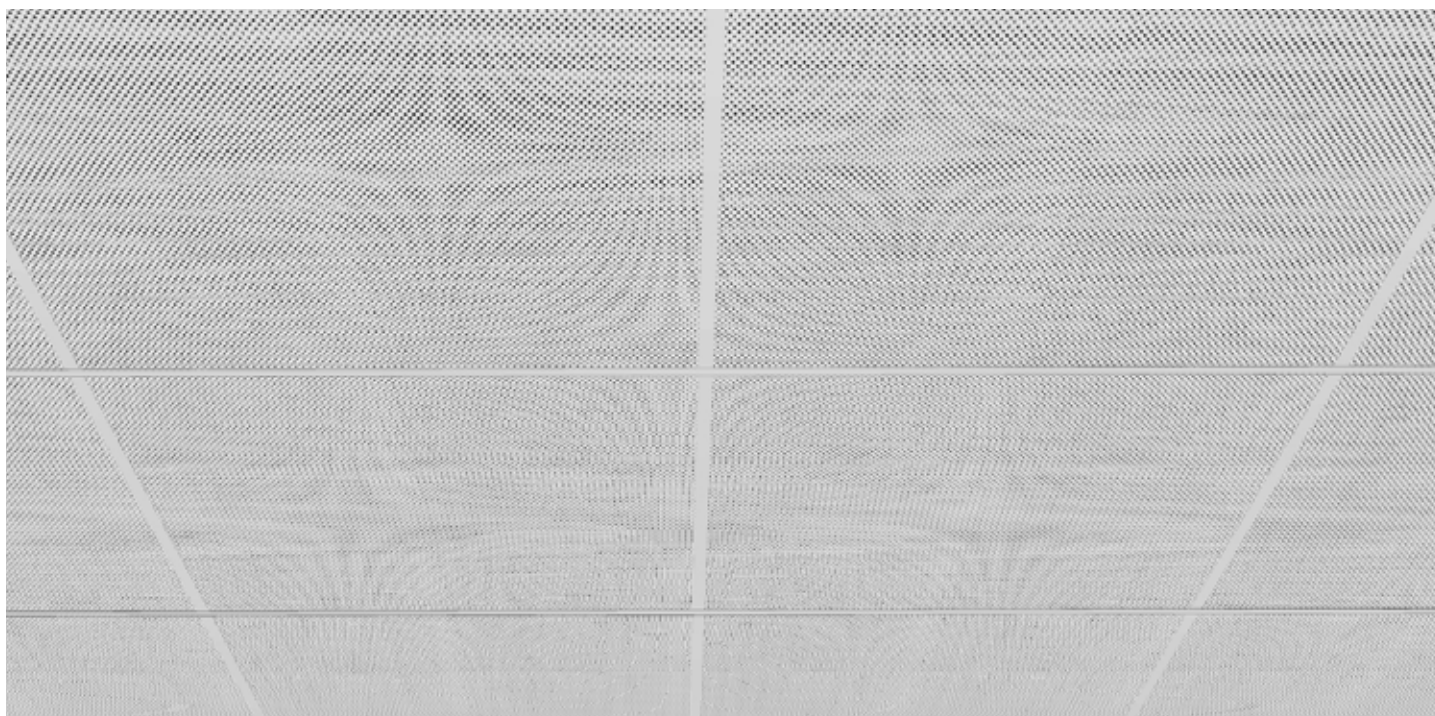

Description

The "H" panel was created to answer the most practical requirements, while providing a simple and attractive design.

Mounted on the T24 structure, it is a product destined to areas where it is necessary constant inspection, in fact the inspection of a panel is allowed without any special tools.

Thanks to its particular section, the panel is coplanar with the structure.

This guarantees uniformity on a visual level, ensuring a good yield both in case of very wide surfaces and in case of local ,or areas, with smaller dimensions.

Main features

Panel module

-Mod. H: 600x600 mm

Material and Colour

-Coil coated Steel:
RAL 9010, 9003, 9006
-Powder coated Steel:
RAL 9010, 9003, 9006
-Coil coated Aluminum:
RAL 9003,9006
(other RAL colours available
on request)

Sound absorption

TNT black

Panel H

Structure

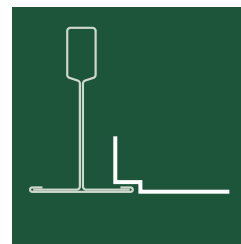
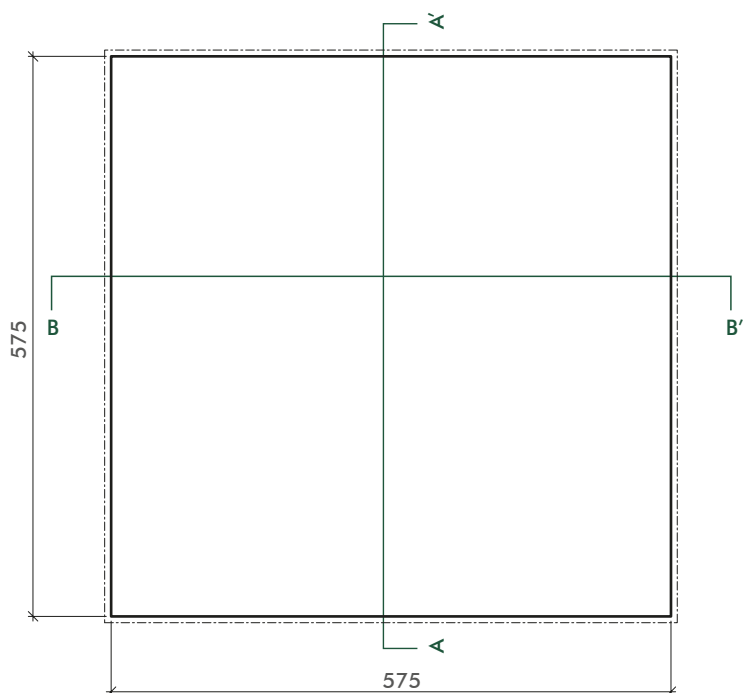

T24

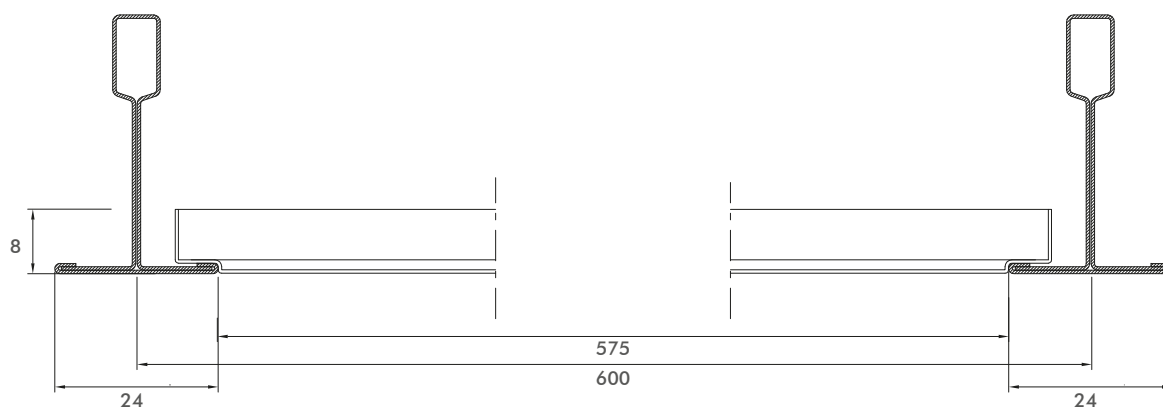
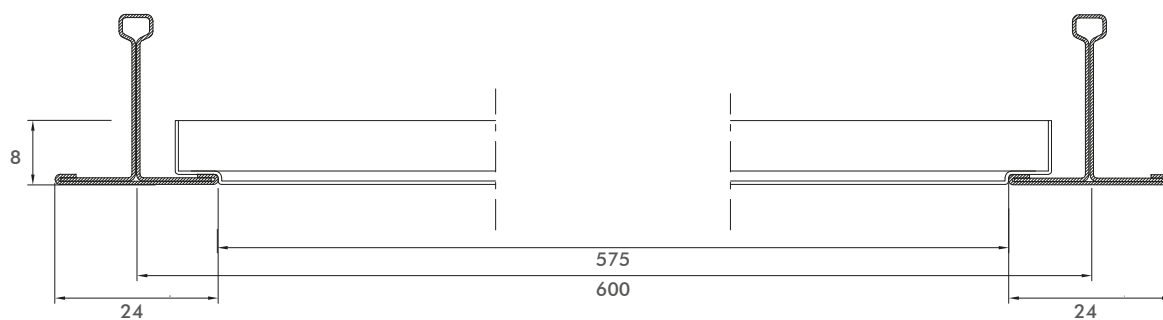
Section A - A' _ on T24 structure _ module 600x600 mm**Sezione B - B' _ on T24 structure _ module 600x600 mm**

Performance and technical data



Perforation
type



α_w *



Classe**



Recycled
content (%)***



Reaction to
fire class****



%RH

| Perforation type | α_w * | Classe** | Recycled content (%)*** | Reaction to fire class**** | %RH |
|----------------------|--------------|----------|-------------------------|----------------------------|-----|
| Panel not perforated | 0,10 | NC | <30 | A1 | 95 |
| R0701 | 0,55 | D | <30 | A1 | 95 |
| R1511 | 0,70 | C | <30 | A1 | 95 |
| R211 | 0,70 | C | <30 | A1 | 95 |
| R2516 | 0,75 | C | <30 | A1 | 95 |
| D1522 | 0,75 | C | <30 | A1 | 95 |
| D222 | 0,70 | C | <30 | A1 | 95 |
| Acoustic R1511 | 1,00 | A | ≤30 | A1 | 95 |
| Acoustic D1522 | 1,00 | A | ≤30 | A1 | 95 |

* including non-woven fabric (black TNT) certified and hot applied.

** according to EN ISO 11654

*** please note that all aluminum and steel products are 100% recyclable.

**** Intended use of the product according to EN13964: 2014 / A1: 2006: Components of suspended ceiling membranes for internal use in buildings. System of assessment and verification of constancy of performance of the construction product: SYSTEM 3.

***** for any other technical information, please contact our sales or technical office.

Perimetral's details

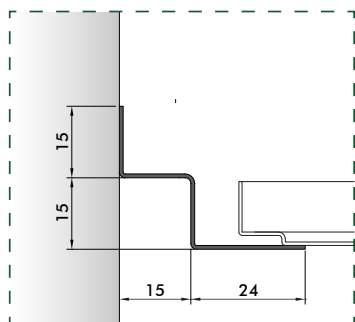

P11_L 3000 mm

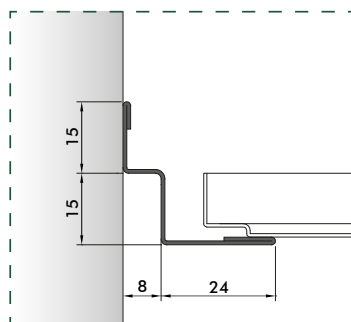

P11/A_L 3050 mm

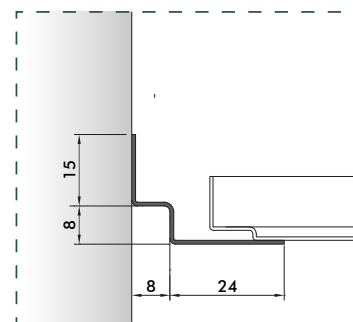

P12_L 3000 mm

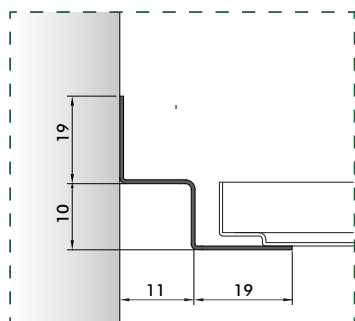

P15/A_L 3000 mm

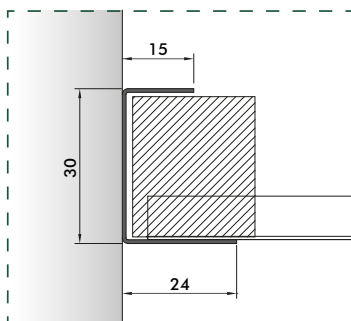

P10 * _L 3000 mm

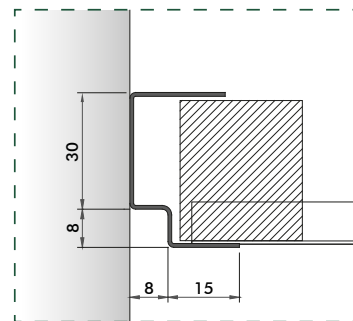

P13 * _L 3000 mm

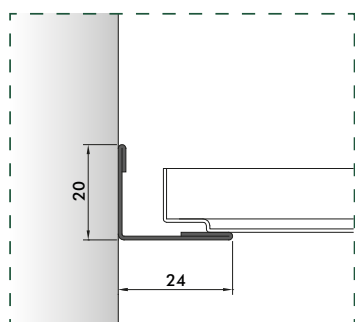

P2_L 3000 mm

Each profile can be achieved with customized section in according to customer's requests.

* Supplied on request with polystyrene to maintain in the form the cut panel (supplied not pre-assembled)

Perforation Options

Regular

R0701

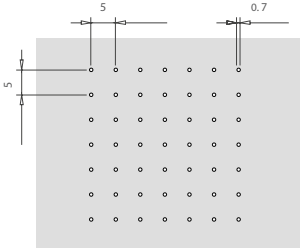

aw 0.55 - EXTRA MICRO PERFORATION
 Diameter : 0.7 mm
 Perforation area : regular central or total
 Inter-axes : 5x5 mm
 Perforation surface : 1.5% approx.

R1511

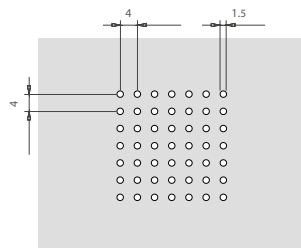

aw 0.70 - MICRO PERFORATION
 Diameter: 1.5 mm
 Perforation area: regular central or total
 Inter-axes: 4x4 mm
 Perforation surface: 11% approx.

R1610

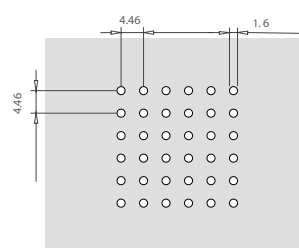

Diameter: 1.6 mm
 Perforation area: regular central or total
 Inter-axes: 4.46x4.46 mm
 Perforation surface: 10% approx.

R211

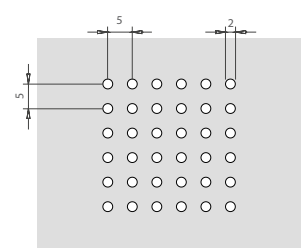

aw 0.70
 Diameter: 2 mm
 Perforation area: regular central or total
 Inter-axes: 5x5 mm
 Perforation surface: 11% approx.

R2516

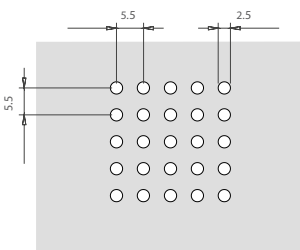

aw 0.75
 Diameter: 2.5 mm
 Perforation area: regular central or total
 Inter-axes: 5.5x5.5 mm
 Perforation surface: 16% approx.

R308

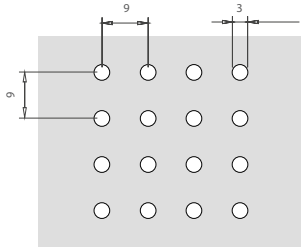

Diameter: 3 mm
 Perforation area: regular central or total
 Inter-axes: 9x9 mm
 Perforation surface: 8% approx.

R4530

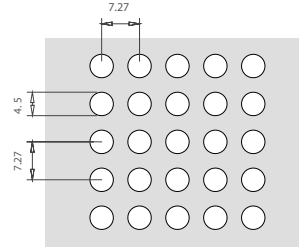

Diameter: 4.5 mm
 Perforation area: regular central or total
 Inter-axes: 7.27x7.27 mm
 Perforation surface: 30% approx.

Diagonal

D1522

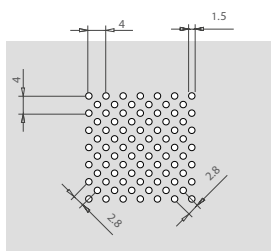

aw 0.75 - MICRO PERFORATION
 Diameter: 1.5 mm
 Perforation area: diagonal central or total
 Inter-axes: 4x4 mm
 Perforation surface: 22% approx.

D220

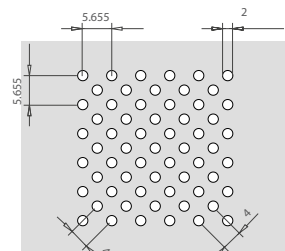

Diameter: 2 mm
 Perforation area: diagonal central or total
 Inter-axes: 5.655x5.655 mm
 Perforation surface: 20% approx.

D222

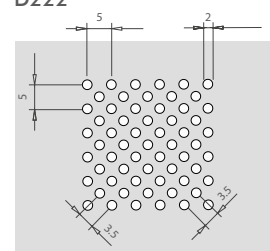

aw 0.70
 Diameter : 2 mm
 Perforation area: diagonal central or total
 Inter-axes: 5x5 mm
 Perforation surface : 22% approx.

D316

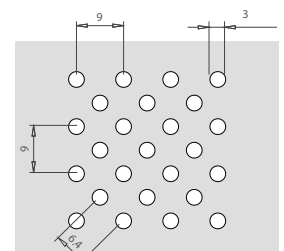

Diameter: 3 mm
 Perforation area: diagonal central or total
 Inter-axes: 9x9 mm
 Perforation surface: 16% approx.

D1620

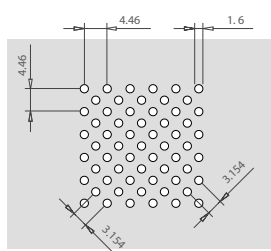

Diameter: 1.6 mm
 Perforation area: diagonal central or total
 Inter-axes: 4.46x4.46 mm
 Perforation surface: 20% approx.

Perforation Options

Square

Q540

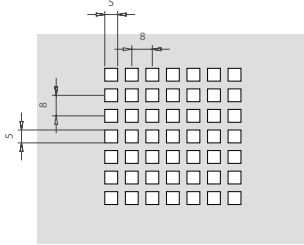

Hole: 5x5 mm
 Perforation area: regular central or total
 Inter-axes: 8x8 mm
 Perforation surface: 40% approx.

Q1045

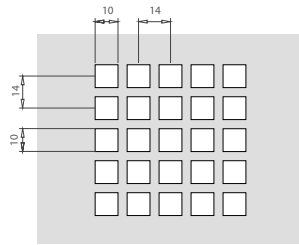

Hole: 10x10 mm
 Perforation area: regular central or total
 Inter-axes: 14x14 mm
 Perforation surface: 45% approx.

Q1020

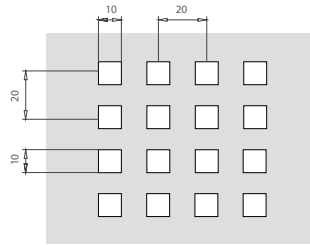

Hole: 10x10 mm
 Perforation area: regular central or total
 Inter-axes: 20x20 mm
 Perforation surface: 20% approx.

Q509

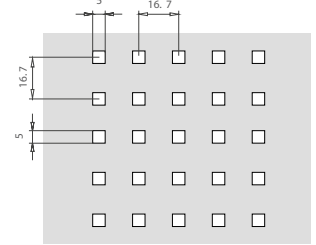

Hole: 5x5 mm
 Perforation area: regular central or total
 Inter-axes: 16.7x16.7 mm
 Perforation surface: 9% approx..

Hexagonal

E2530

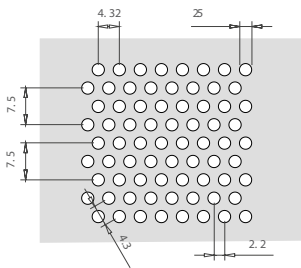

Diameter: 2.5 mm
 Perforation area: diagonal central or total
 Inter-axes: 4.3x7.5 mm
 Perforation surface: 30% approx.

E332

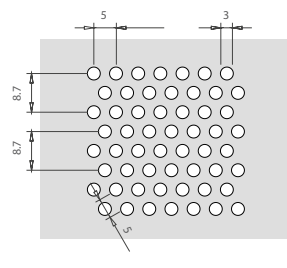

Diameter: 3 mm
 Perforation area: diagonal central or total
 Inter-axes: 5x8.7 mm
 Perforation surface: 32% approx.

04/5,5x5,5

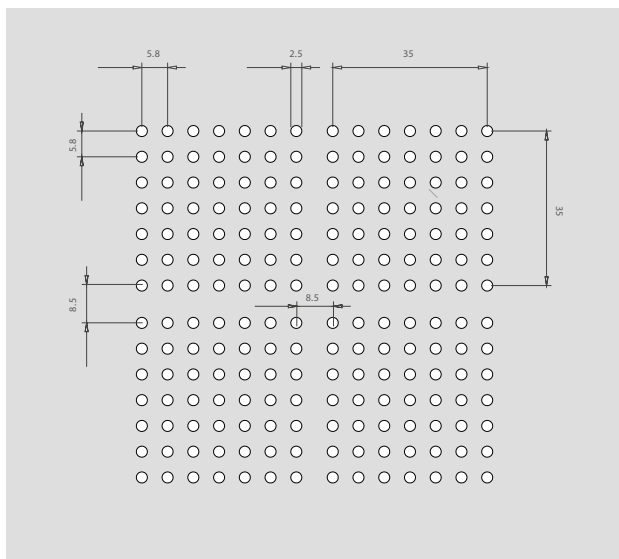

Diameter: 2.5 mm
 Perforation area: regular 35x35 mm
 Inter-axes: 8.5 mm
 Perforation surface: 15% approx.

General informations

Technical Standards

All Profilsystem products are CE marked according to EN 13964. They are also accompanied by the Declaration of Performance (D.O.P.) as required by European regulation 305/11 concerning the placing of construction products on the market.

For applications in particularly aggressive environments such as swimming pools, industrial installations with chemical and / or corrosive fumes, check the most suitable material and surface treatment with the technical or commercial office of Profilsystem.

Storage

All products are carefully packed and placed on special pallets and secured by strapping and film wrapping. On request we can provide the package complete of cardboard corners, bubble wrap and polystyrene to reduce the risks during transport.

It is always recommended to handle all packaging with the most care, avoiding shocks and practices that damage the contents. The packed material is stored in closed, clean and dry places until the time of pic-up.

Do not expose filmed products to heat sources and do not leave them under the sun.

Installation

The metal ceiling are installed manually by the installer depending on the type and model you choose.

The material should be stored in closed, clean and dry places until the time of installation.

Do not rest on the ground and not leave the products on site without the original package issued at the time of delivery.

Avoid the contact between material and water, solvents, degreasers and aggressive liquids.

Cleaning and Maintenance

Metal ceilings, thank to the easy washing and cleaning are also a guarantee in terms of hygiene.

To remove dust, stains or smudges you can use carefully a clean, dry cloth or moistened with neutral detergent, or non-abrasive and non-aggressive disinfectants.



Give life to your project

ITALY

Head quarter & showroom

Via Don Luigi Sturzo,3 - 20822 Seveso (MB) Italy
tel: +39 0362 625652 - fax: +39 0362 306733
www.profilsystem.com

DUBAI

Sales offices & showroom

TOP 27 CONSULTING JLT
Office 3205 - JBC2
Cluster V - JLT
Dubai - United Arab Emirates
middleeast@profilsystem.com

CHILE

Sales offices & showroom

COMERCIAL E.V.A. Limitada
Avenida La Dehesa 1844
Ufficio 714
Lo Barnechea, Santiago de Chile
tel: +59 9 51599037
info@nenzi.cl

SPAIN

Sales offices & showroom

PROFILSYSTEM EPC
Techos de Aluminio
C/ Lluís Companys, 52
08810 Sant Pere de Ribes, Barcelona
tel: +34 666 431 921
info@profilsystem.es

Our offices are at your disposal

SALES OFFICE ITALY:

Elis Zappino
elis@profilsystem.com
Skype ID [elis.zappino](#)

Dott. Riccardo Ghezzi
riccardo@profilsystem.com
Skype ID [ghezziriccardo](#)

EXPORT OFFICE:

Dott. Alexa Maj
export@profilsystem.com
Skype ID [Alexa Maj](#)

TECHNICAL OFFICE:

Arch. Manuela De Cristofaro
tecnico@profilsystem.com
Skype ID [Manuela De Cristofaro](#)

SHIPPING OFFICE:

Chiara Talon
chiara.talon@profilsystem.com
Skype ID [talon.chiara](#)